

1

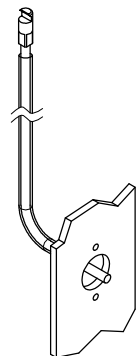

2

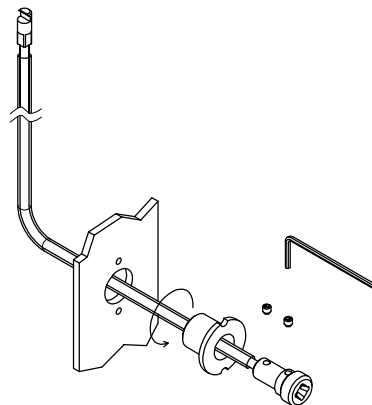

3

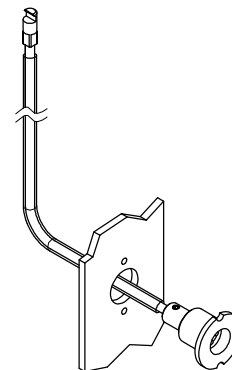

4

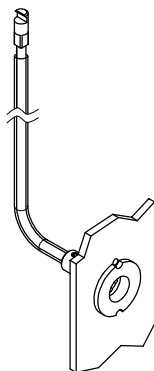

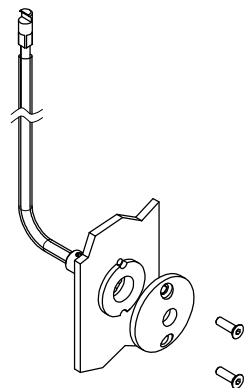

5

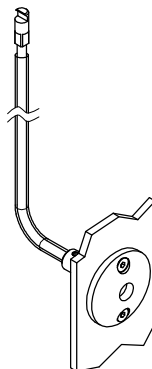

6



7

N° REVISIONE	DESCRIZIONE	DATA
		DESCRIZIONE: MONTAGGIO POMOLO A SCOMPARSA
PROG.: Ing. G. Nicolosi		DISEGNO: SL24P IM SC
VERIF.: G.N.		
DATA: 19.04.02		TOLL. GEN.:
CLIENTE:		SCALA: 1:2

Disegno di proprietà della Pellini S.p.A.. Vietato esporlo o riprodurlo senza autorizzazione.